

# *MESSRS.*

---

## SPECIFICATION FOR APPROVAL

## 承 認 書

Product	MAGNETIC BUZZER INDICATOR
Part No.	AX-1003-LF (RoHS)
Customer Approval	

Approved By	Checked By	Made By
工程 部 王台平 NOV-07-2005	工程 部 劉民祥 NOV-07-2005	工程 部 許俊程 NOV-07-2005



**ADVANCED ACOUSTIC TECHNOLOGY CORP.**

**苙 翔 科 技 股 份 有 限 公 司**



ISO 9001 Certified

2F, No.207, Sec. 6, Chung Shan N. Rd., Taipei

Tel: +886-2-88665255

Fax: +886-2-88665250

<http://www.aatc.com.tw>

# 1. Specifications

AX-1003-LF

Items		Units	Specifications	Conditions
01	Rated Voltage	VDC	3.0	Response Time 0.5 Sec
02	Operating Voltage	VDC	2.0 ~ 5.0	Volts D.C
03	Consumption Current	mA (Max)	Mean 25	Applying rated voltage
			Peak 75	
04	Direct Current Resistance	Ohm	None	
05	Sound Output	dBA (min)	80	Distance at 10cm, applying rated voltage
06	Basic Frequency	Hz	2500± 200	
07	Operating Temp.	°C	-30 ~ +75	
08	Storage Temp.	°C	-40 ~ +85	
09	Weight	Gram	1.0	

## 2. Measuring Method

### 2-1. Test Condition

STANDARD

Temperature : 15 ~ 35°C

Relative humidity : 25% ~ 85%,

Atmospheric pressure : 860mbar to 1060mbar.

JUDGEMENT

Temperature : 20±3°C

Relative humidity : 60% ~ 70%,

Atmospheric pressure : 860mbar to 1060mbar

### 2-3. Standard Test Fixture

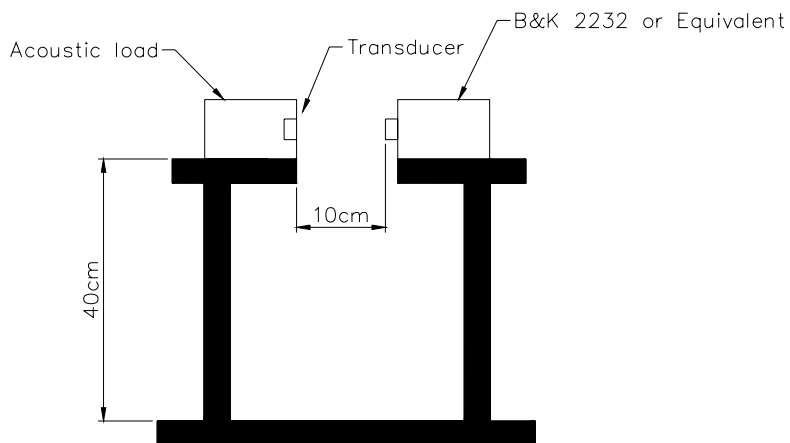

### 2-4. Frequency Response Curve

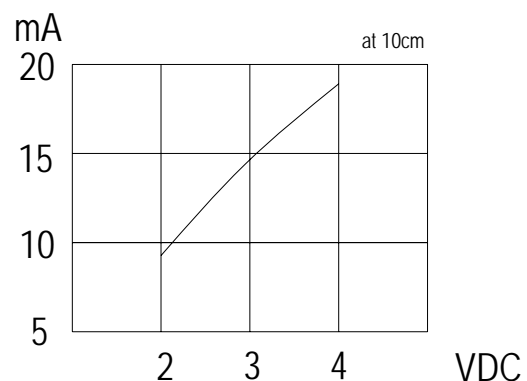
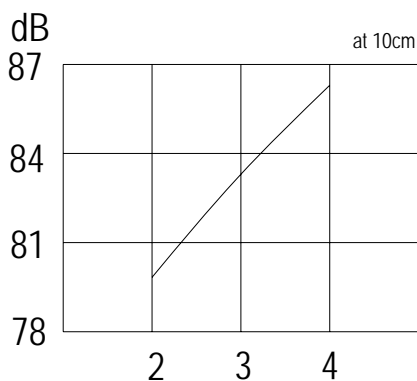

REV NO.	REVISION NOTE	APPROVAL	DATE
---------	---------------	----------	------

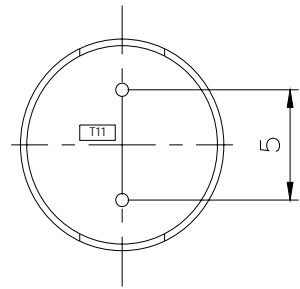
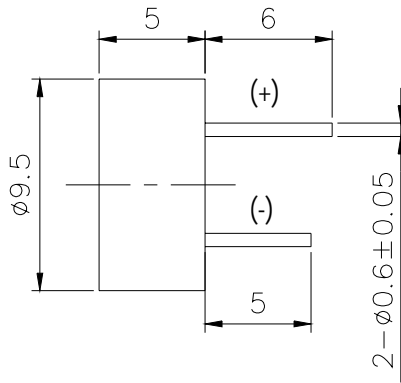
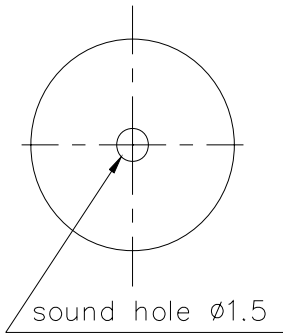
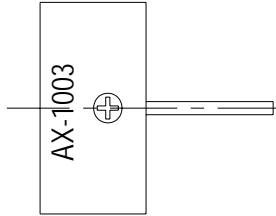

TITLE: SOUND TRANSDUCER DIMENSIONS		DRAWN: JCHEN	11/07/2005	SCALE: 3/1	SHEET: 1 OF 1
PART NO.	AX-1003-LF	DESIGNED:	R&D OF AAT	UNITS:	mm
DWG NO.	DTE-2074	CHECKED:		TOLERANCE $\pm 0.3$	
		APPROVAL:		UNLESS OTHERWISE SPECIFIED:	
		MATERIAL:	NORYL	ONE PLACE DECIMAL $\pm$ ***	
				TWO PLACE DECIMAL $\pm$ ***	
				THREE PLACE DECIMAL $\pm$ ***	



苙翔科技股份有限公司  
ADVANCED ACOUSTIC TECHNOLOGY CORPORATION

## 4.RELIABILITY TEST

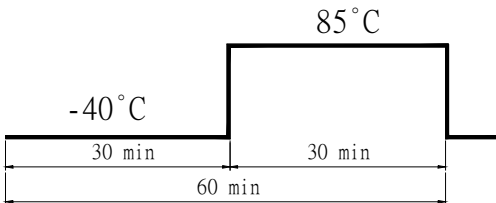
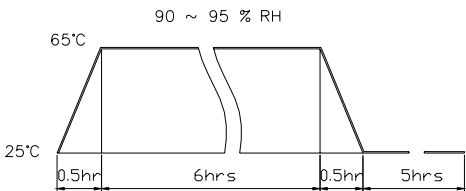
Item	Test conditions	Evaluation standard
01 High temp.Storage life	The part shall be capable of withstanding a storage Temperature of 85°C for 96 hours.	After the test the part shall meet specifications without Any degradation in appearance and performance except S.P.L S.P.L shall be 73dB or more.
02 Low temp.Storage life	The part shall be capable of withstanding a storage Temperature of -40°C for 96 hours.	
03 Temp. cycle	The part shall be subjected 10 cycles. One cycle shall consist of; 	
04 Temp./Humidity cycle	The part shall be subjected 10 cycles. One cycle shall be 12 hours and consist of; 	
05 Operating life	Rated Voltage applied. <ol style="list-style-type: none"> <li>1. Ordinary temperature The part shall be subjected to 1000 hours at room temperature (25 ±10°C)</li> <li>1. High temperature The part shall be subjected to 500 hours at 75°C</li> <li>2. Low temperature The part shall be subjected to 500 hours at -30°C</li> </ol>	
06 Vibration	The part shall be subjected to a vibration cycle of 10Hz to 55Hz to 10Hz in a period of 1 minute. Total peak amplitude shall be 1.52mm (9.3G). The vibration test shall consist of 2 hours per plane in each three mutually perpendicular planes for a total time of 6 hours.	

Item		Test conditions	Evaluation standard
07	Fixed drop	The part shall be mounted on standard pc board and dropped from a height of 152cm onto a concrete floor 5 times in each 6 planes.(a total of 30 times)	<p>After the test the part shall meet specifications without Any degradation in appearance and performance except S.P.L</p> <p>S.P.L shall be 74dB or more.</p>
08	Free drop	The part only shall be dropped from a height of 75cm onto a 40mm thick wooden board 3 times in 3 axes (X.Y.Z). (a total of 9 times).	
09	Solder heat resistance	Soldering into solderbath : $350\pm 5^{\circ}\text{C}$ Soaking time : $3.5\pm 0.5$ sec	
10	Solder ability	Soldering : $250\pm 5^{\circ}\text{C}$ / 5 Sec. $350\pm 5^{\circ}\text{C}$ / 1.5 Sec Soldering t into solderbath : $250\pm 5^{\circ}\text{C}$ / 2 sec.	
11	Lead strength	Pull lead with a force of 10N,on the direction of the lead axis for 10 : $10\pm 1$ sec	
12	Washability	Solvent : deionized water Solvent temp. : $55\pm 5^{\circ}\text{C}$ Soaking time : $5\pm 0.5$ min.	