

MESSRS

SPECIFICATION FOR APPROVAL

承 認 書

Product	DYNAMIC SPEAKER
Part No.	AK-4032BB-2-LF
Customer Approval	

Approved By	Checked By	Made By



ADVANCED ACOUSTIC TECHNOLOGY CORP.

苙翔科技股份有限公司



ISO 9001 Certified

2F, No.207, Sec. 6, Chung Shan N. Rd., Taipei

Tel: +886-2-88665255

Fax: +886-2-88665250

<http://www.aatc.com.tw>

SPECIFICATION

AK-4032BB-2-LF

ITEM		SPECIFICATIONS	
01	Type	Dynamic speaker	
02	Dimension	External diameter 40 mm	
03	Rated Input Power	0.25 W	
04	Max Input Power	0.5 W	
04	Impedance	32 ohm \pm 15% at 1K Hz	
05	Resonance Frequency (Fo)	600 Hz \pm 20% at Fo, 1V	
06	Sensitivity (S.P.L.)	90dB(0.1W/0.1m) \pm 3 dB	at AVE 0.8K,1.0K,1.2K,1.6K(Hz).
07	Frequency Range	Fo – 6KHz	
08	Total Harmonics Distortion	Less than 8 % at 1K Hz.	
09	Max. Input Power	Must be normal at 1.5W white noise for 1 minute.	
10	Voice Coil	Diameter 13.28 mm	
11	Magnet	Rare earth permanent (Nd-Fe-B) magnet Φ 12.5 X 1.5t mm	
12	Weight	9.5g \pm 2g	
13	Appearance	Should not exist any obstacle to be harmful to normal operation; damages, cracks, rusts and distortions, etc.	
14	Operation Test	Must be normal at program source 0.1W	
15	Buzz, Rattle, etc.	Should not be audible at 1.79V sine Wave between Fo to 20KHz	
16	Polarity	When positive voltage is applied to the terminal marked (+), diaphragm should move to the front.	
17	Terminal Strength	Capable of withstand 1kg load for 30 seconds without resulting in any damage or rejection.	
18	Temperature	Operating temperature: -20°C to +60°C Storage temperature: -30°C to +70°C	

1. MEASURING METHOD

2-1 .Test Condition

STANDARD

Temperature : 15 ~ 35°C

Relative humidity : 45% ~ 85%,

Atmospheric pressure : 860mbar to 1060mbar.

JUDGEMENT

Temperature : 20±3°C

Relative humidity : 60% ~ 70%,

Atmospheric pressure : 860mbar to 1060mbar

2-2 . Standard Test Fixture

1.Input Power : 0.1W(1.79V)

2.Zero Level : -dB

3.Mode : SPEAKER

4.potentiometer Range : 50dB

5.Sweep Time : 0.5sec

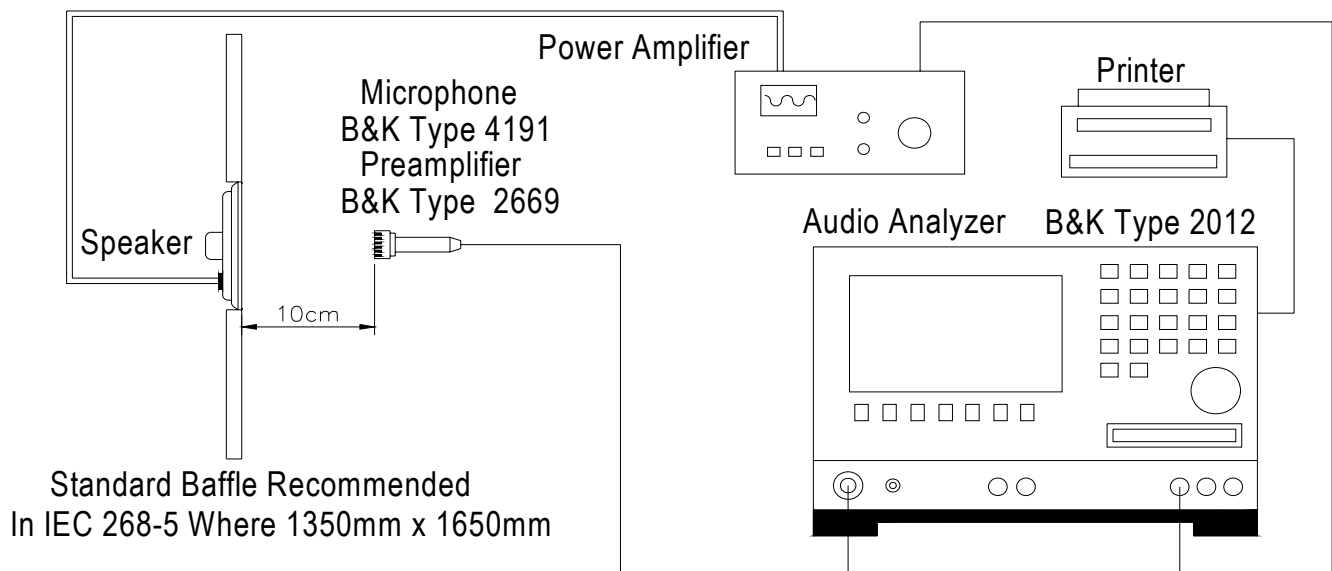

2-3. Frequency Response Curve

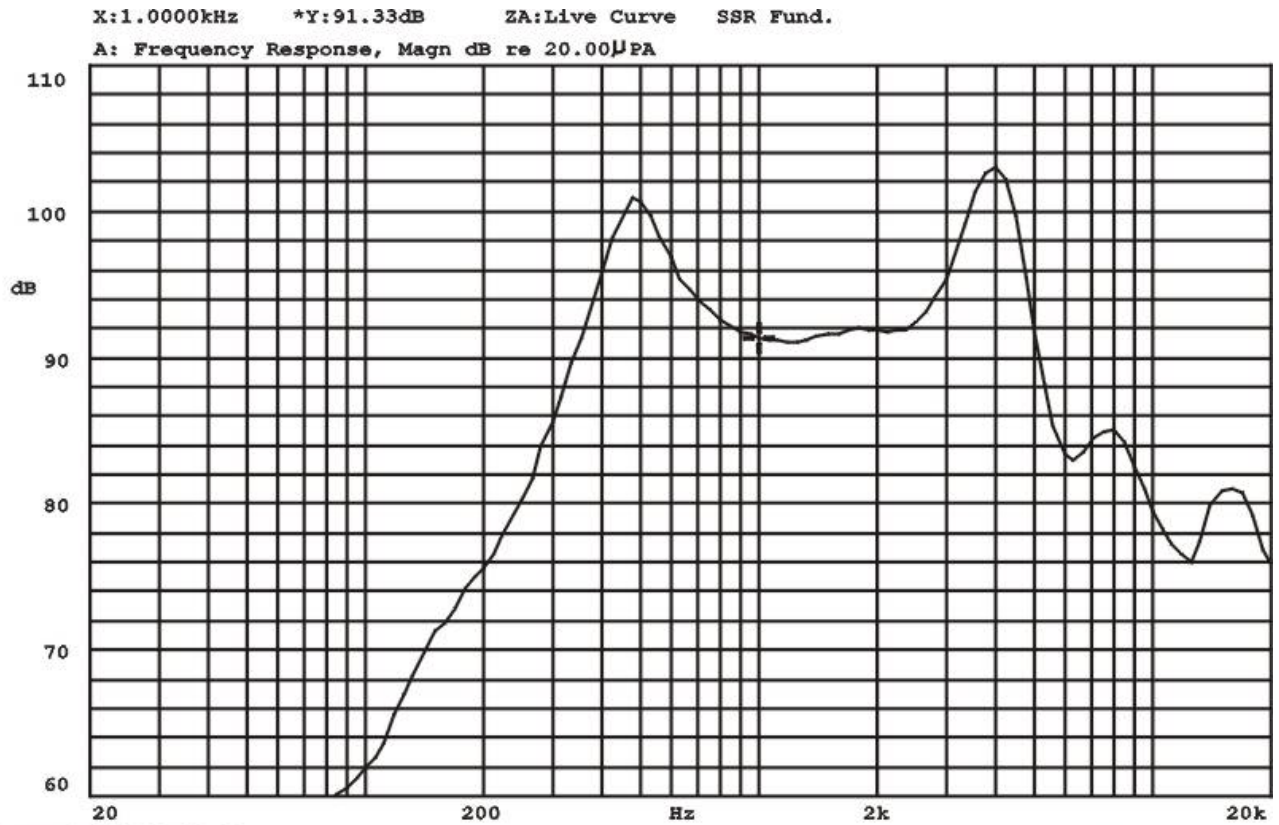

Mode: SPEAKER



2-4. Impedance Curve

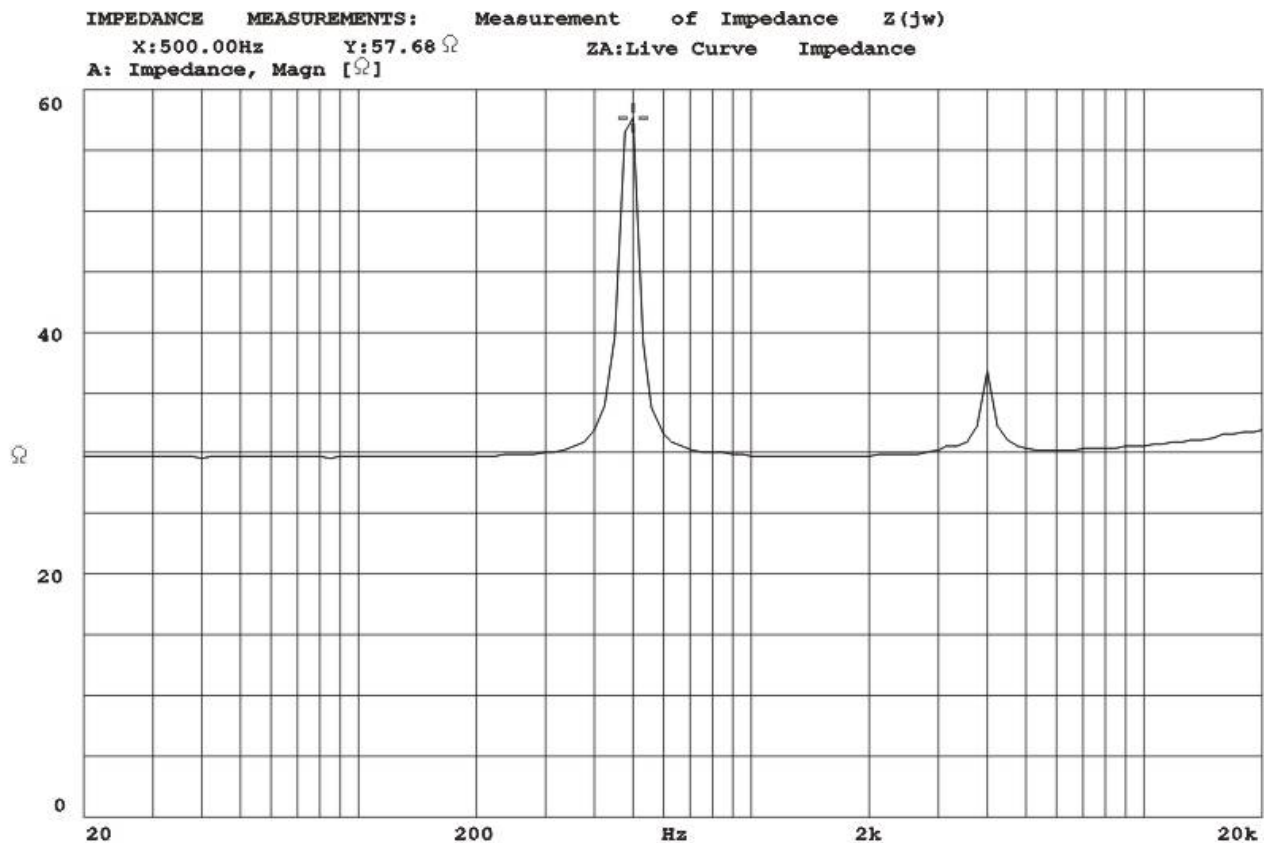

Mode: Z(j ω)



REV NO.	REVISION NOTE	APPROVAL	DATE
---------	---------------	----------	------

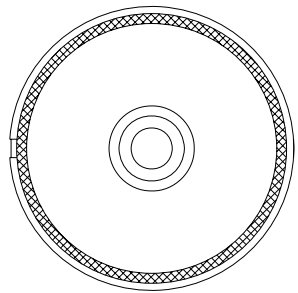
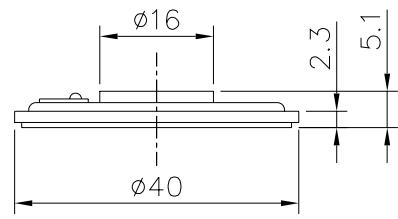
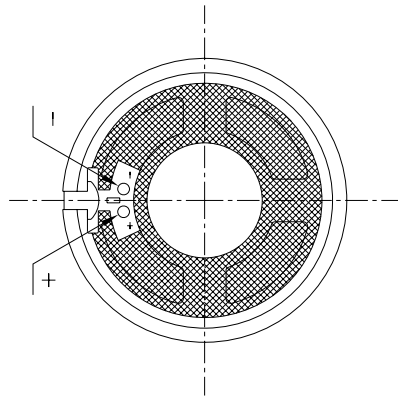

TITLE: DYNAMIC SPEAKER		DRAWN: Jason 2008-11-20	SCALE: 1:1	SHEET: 1 of 1
PART NO. AK-4032BB-2-LF	1 REV	DESIGNED: R&D OF AAT	UNITS: mm	
DWG NO. DTS-1222		CHECKED:	TOLERANCE ± 0.2	
		APPROVAL:	UNLESS OTHERWISE SPECIFIED:	
		MATERIAL: *****	ONE PLACE DECIMAL \pm ***	
			TWO PLACE DECIMAL \pm ***	
			THREE PLACE DECIMAL \pm ***	



苙翔科技股份有限公司
 ADVANCED ACOUSTIC TECHNOLOGY CORPORATION

2. RELIABILITY TESTS

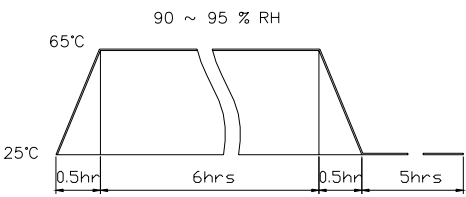
Items.		Specifications
01	High temp. Test	Keep 96 hours at $+70^{\circ}\text{C}\pm 3^{\circ}\text{C}$ and leave 3 hours in normal temperature and then check
02	Low temp. Test	Keep 96 hours at $-20^{\circ}\text{C}\pm 3^{\circ}\text{C}$ and leave 3 hours in normal temperature and then check
03	Humidity test	Keep 96 hours at $+60^{\circ}\text{C}\pm 3^{\circ}\text{C}$ relative humidity 95% and leave 3 hours in normal temperature and then checked.
04	Temp./Humidity cycle	<p>The part shall be subjected 5 cycles. One cycle shall be 12 hours and consist of;</p> 
05	Thermal cycle test.	Low temperature: $-40^{\circ}\text{C}\pm 3^{\circ}\text{C}$, temperature: $+70^{\circ}\text{C}\pm 3^{\circ}\text{C}$, cycle: 1 hour/cycle each, and then keep 5 cycles in a room.
06	Vibration	10~200~10Hz sin-wave sweep 15min. 5G(constant) X,Y, Z 3 direction. 2 hours each, total 6 hours.
07	Fix drop test	Fix on jig. Then drop from 152cm height to the concrete floor X,y, z 6 direction. 5 times each, total 30 times.
08	Free drop test	Free drop from 100cm height to the concrete floor X,y, z 6 direction. 1 times each, total 6 times.
09	Load test	Rated Power White noise is applied for 96 hours
10	Max Power test	Max power 1 min on – 2 min off 10 cycles.
11	Terminal strength test	Capable of withstand 1kg load for 30 seconds without resulting in any damage or rejection.
<p>CRITERION :</p> <p>After these test , the change of S.P.L shall be within ± 3 dB .</p>		

SOLDERING CONDITION

Recommend using constant branding iron in 30W, and in temperature range $350\pm 10^{\circ}\text{C}$.

Soldering time 2 seconds.